

NDS Standard Series



High-quality valve boxes designed for longevity



- ✓ Reinforced covers for heavy loads
- ✓ UV resistance
- ✓ Integrated nut for bolt down capability
- ✓ Available in wide variety of sizes and colours
- ✓ Overlapping covers prevent dirt and grass from settling in between body and cover
- ✓ The bayonet twist-on cover ensures easy removal on 6" round covers

Love what you see? Here are some more products you may like.



EZ Roll™ Grass Paver



NORMA PN 10



NORMA PC Dripline



Order a sample online!

Technical Information

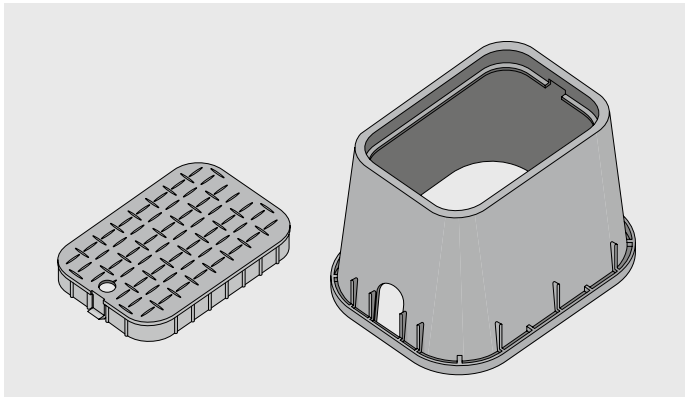

Applications

NDS Standard Series Valve Boxes are used in residential and commercial applications. They are designed to offer years of service under most demanding conditions and have designations for irrigation control valve and reclaimed water.

Material

One piece moulded of polyolefins (polyethylene and polypropylene). UV inhibitors added in to prevent discoloration and cracking.

NOTE: Please refer to the description of the Box & Cover set to identify those with bolt. For others, the bolt needs to be ordered separately.

NDS Standard Series 6" Round Valve Boxes

The NDS Standard Series 6" round body is tapered and has a minimum wall thickness of 5 mm. The body has a double wall in the top cover seat area, with a minimum thickness of 3 mm. The bottom of the body has a 6 mm flange. The 6" round cover has an average thickness of 5 mm.

Product picture	NDS Standard Series 6" Round Valve Boxes						
	Part number		Description	Colour		Size (Ø cm)	Packaging details
	EMEA reference	USA reference		Box	Cover		
	Box & Cover						
	0800 2740 004	107BC	6" Round Box; Round Overlapping Cover - ICV	Black	Green	15	250
	0800 2740 090	107BC BLK	6" Round Box; Round Overlapping Cover - ICV	Black	Black	15	250
	0800 2740 005	107BC SAND	6" Round Box; Round Overlapping Cover - ICV	Gold	Gold	15	250
	0800 2740 091	108BC	6" Round Box; Round Overlapping Cover - ICV	Green	Green	15	250
	0800 2740 008	107BCR	6" Round Box; Round Overlapping Cover - Reclaimed Water	Black	Purple	15	250
	0800 2740 092	107BCR BLK	6" Round Box; Round Overlapping Cover - Reclaimed Water	Black	Black	15	250
	0800 2740 015	107PBCR	6" Round Box; Round Overlapping Cover - Reclaimed Water	Purple	Purple	15	250
	Cover only						
	0800 2740 009	107C	6" Round Overlapping Cover - ICV		Green	15	800
	0800 2740 093	107C BLK	6" Round Overlapping Cover - ICV		Black	15	800
	0800 2740 094	107C BRN	6" Round Overlapping Cover - ICV		Brown	15	800
	0800 2740 010	107C SAND	6" Round Overlapping Cover - ICV		Gold	15	800
	0800 2740 012	107CR	6" Round Overlapping Cover - Reclaimed Water		Purple	15	800
	Box only						
	0800 2740 002	107B	6" Round Box	Black		15	250
0800 2740 095	108B	6" Round Box	Green		15	250	

NDS Standard Series 10" Round Valve Boxes

The NDS Standard Series 10" round body is tapered and has a minimum wall thickness of 5 mm. The cover seat area has 6 structural support ribs on the underside of the seat, each with a minimum thickness of 6 mm. The bottom of the body has a 12 mm flange. The 10" round cover has an average thickness of 6 mm. The valve box has a 5/16" brass nut for bolt-down as a standard feature.

Product picture	NDS Standard Series 10" Round Valve Boxes						
	Part number		Description	Colour		Size (Ø cm)	Packaging details
	EMEA reference	USA reference		Box	Cover		Pallet quantity (pcs)
	Box & Cover						
	0800 2740 021	111BCB	10" Round Box; Round Overlapping Cover with Bolt - ICV	Black	Green	25	180
	0800 2740 096	112BCB	10" Round Box; Round Overlapping Cover with Bolt - ICV	Green	Green	25	180
	0800 2740 097	111BC BLK	10" Round Box; Round Overlapping Cover - ICV	Black	Black	25	180
	0800 2740 020	111BC SAND	10" Round Box; Round Overlapping Cover - ICV	Gold	Gold	25	180
	0800 2740 023	111BCR	10" Round Box; Round Overlapping Cover - Reclaimed Water	Black	Purple	25	180
	0800 2740 098	111BCR BLK	10" Round Box; Round Overlapping Cover - Reclaimed Water	Black	Black	25	180
	0800 2740 027	111PBCR	10" Round Box; Round Overlapping Cover - Reclaimed Water	Purple	Purple	25	180
	0800 2740 099	112BCRG	10" Round Box; Round Overlapping Cover - Reclaimed Water	Green	Green	25	180
	Cover only						
		0800 2740 024	111C	10" Round Overlapping Cover - ICV		Green	25
	0800 2740 100	111C BLK	10" Round Overlapping Cover - ICV		Black	25	300
	0800 2740 101	111C BRN	10" Round Overlapping Cover - ICV		Brown	25	300
	0800 2740 025	111C SAND	10" Round Overlapping Cover - ICV		Gold	25	300
	0800 2740 026	111CR	10" Round Overlapping Cover - Reclaimed Water		Purple	25	300
	0800 2740 102	111CRG	10" Round Overlapping Cover - Reclaimed Water		Green	25	300
Box only							
	0800 2740 016	111B	10" Round Box	Black		25	180
	0800 2740 028	112B	10" Round Box	Green		25	300
Bolt							
	0800 2740 018	111BB	1 1/4" x 5/16" SS Bolt	Steel		N / A	600 pcs / box

VALVE BOXES

NDS Standard Series 14" x 19" Rectangular Valve Boxes

The NDS Standard Series 14" x 19" body is tapered and has a minimum wall thickness of 5 mm. The body has a double wall in the top cover seat area, with a minimum thickness of 6 mm. The cover seat area has 16 structural support ribs on the underside of the seat, each with a minimum thickness of 6 mm. The bottom of the body has a 12 mm flange. The cover has an average thickness of 6 mm. The valve box has a 3/8" brass nut for bolt-down as a standard feature.

Product picture	NDS Standard Series 14" x 19" Rectangular Valve Boxes						
	Part number		Description	Colour		Size (W x L x H cm)	Packaging details
	EMEA reference	USA reference		Box	Cover		Pallet quantity (pcs)
	Box & Cover						
	0800 2740 105	114BCB	14" x 19" x 12" Box; Overlapping Cover with Bolt - ICV	Green	Green	36 x 48 x 30	78
	0800 2740 034	113BCB	14" x 19" x 12" Box; Overlapping Cover with Bolt - ICV	Black	Green	36 x 48 x 30	78
	0800 2740 107	113BCB SAND	14" x 19" x 12" Box; Overlapping Cover with Bolt - ICV	Gold	Gold	36 x 48 x 30	78
	0800 2740 108	113BCBLK	14" x 19" x 12" Box; Overlapping Cover - ICV	Black	Black	36 x 48 x 30	78
	0800 2740 035	113BCR	14" x 19" x 12" Box; Overlapping Cover - Reclaimed Water	Black	Purple	36 x 48 x 30	78
	0800 2740 109	113BCRBLK	14" x 19" x 12" Box; Overlapping Cover - Reclaimed Water	Black	Black	36 x 48 x 30	78
	0800 2740 110	113BCRG	14" x 19" x 12" Box; Overlapping Cover - Reclaimed Water	Black	Green	36 x 48 x 30	78
	0800 2740 040	113PBCR	14" x 19" x 12" Box; Overlapping Cover - Reclaimed Water	Purple	Purple	36 x 48 x 30	78
	0800 2740 043	115	14" x 19" x 6" Extension; Overlapping Cover - ICV	Black	Green	36 x 48 x 15	49
	0800 2740 103	116	14" x 19" x 6" Extension; Overlapping Cover - ICV	Green	Green	36 x 48 x 15	49
	0800 2740 104	115BCR	14" x 19" x 6" Extension; Overlapping Cover - Reclaimed Water	Black	Purple	36 x 48 x 15	49
	Cover only						
0800 2740 036	113C	14" x 19" Overlapping Cover - ICV		Green	36 x 48	300	
0800 2740 111	113C BRN	14" x 19" Overlapping Cover - ICV		Brown	36 x 48	300	
0800 2740 037	113C SAND	14" x 19" Overlapping Cover - ICV		Gold	36 x 48	300	
0800 2740 112	113CB	14" x 19" Overlapping Cover - ICV		Black	36 x 48	300	
0800 2740 038	113CR	14" x 19" Overlapping Cover - Reclaimed Water		Purple	36 x 48	300	
0800 2740 113	113CRB	14" x 19" Overlapping Cover - Reclaimed Water		Black	36 x 48	300	
0800 2740 114	113CRG	14" x 19" Overlapping Cover - Reclaimed Water		Green	36 x 48	300	
Box only							
0800 2740 030	113B	14" x 19" x 12" Box	Black		36 x 48 x 30	78	
0800 2740 041	114B	14" x 19" x 12" Box	Green		36 x 48 x 30	78	
0800 2740 029	113-6	14" x 19" x 6" Extension	Black		36 x 48 x 15	49	
0800 2740 115	114-6	14" x 19" x 6" Extension	Green		36 x 48 x 15	49	
0800 2740 045	116-SAND	14" x 19" x 6" Extension	Gold		36 x 48 x 15	49	
Bolt							
0800 2740 031	113BB	2 1/2" x 3/8" SS Bolt	Steel		N / A	600 pcs / box	

NDS Standard Series 13" x 20" Rectangular Valve Boxes

The NDS Standard Series 13" x 20" body is tapered and has a minimum wall thickness of 6 mm. The body has a double wall in the top cover seat area, with a minimum thickness of 6 mm. The cover seat area has 16 structural support ribs on the underside of the seat, each with a minimum thickness of 6 mm. The bottom of the body has a 12 mm flange. The cover has an average thickness of 6 mm. The valve box has a 3/8" brass nut for bolt-down as a standard feature.

Product picture	NDS Standard Series 13" x 20" Rectangular Valve Boxes						
	Part number		Description	Colour		Size (W x L x H cm)	Packaging details
	EMEA reference	USA reference		Box	Cover		Pallet quantity (pcs)
	Box & Cover						
	0800 2740 047	117BC	13" x 20" x 12" Jumbo Box; Overlapping Cover - ICV	Black	Green	33 x 51 x 30	56
	0800 2740 117	117BC BLK	13" x 20" x 12" Jumbo Box; Overlapping Cover - ICV	Black	Black	33 x 51 x 30	56
	0800 2740 048	117BC SAND	13" x 20" x 12" Jumbo Box; Overlapping Cover - ICV	Gold	Gold	33 x 51 x 30	56
	0800 2740 052	118BC	13" x 20" x 12" Jumbo Box; Overlapping Cover - ICV	Green	Green	33 x 51 x 30	56
	0800 2740 118	117BCR	13" x 20" x 12" Jumbo Box; Overlapping Cover - Reclaimed Water	Black	Black	33 x 51 x 30	56
	0800 2740 119	117PBCR	13" x 20" x 12" Jumbo Box; Overlapping Cover - Reclaimed Water	Purple	Purple	33 x 51 x 30	56
	0800 2740 053	119	13" x 20" x 6" Jumbo Extension; Overlapping Cover - ICV	Black	Green	33 x 51 x 15	32
	0800 2740 116	120	13" x 20" x 6" Jumbo Extension; Overlapping Cover - ICV	Green	Green	33 x 51 x 15	32
	0800 2740 054	119 SAND	13" x 20" x 6" Jumbo Extension; Overlapping Cover - ICV	Gold	Gold	33 x 51 x 15	32
	Cover Only						
	0800 2740 049	117C	13" x 20" Overlapping Cover - ICV		Green	33 x 51	180
	0800 2740 120	117C BRN	13" x 20" Overlapping Cover - ICV		Brown	33 x 51	180
	0800 2740 050	117C SAND	13" x 20" Overlapping Cover - ICV		Gold	33 x 51	180
	0800 2740 121	117 CB	13" x 20" Overlapping Cover - ICV		Black	33 x 51	180
	0800 2740 122	117CR	13" x 20" Overlapping Cover - Reclaimed Water		Purple	33 x 51	180
Box Only							
	0800 2740 046	117B	13" x 20" x 12" Jumbo Box	Black		33 x 51 x 15	56
	0800 2740 125	118B	13" x 20" x 12" Jumbo Box	Green		33 x 51 x 15	56
	0800 2740 123	117-6	13" x 20" x 6" Jumbo Extension	Black		33 x 51 x 15	32
	0800 2740 124	118-6	13" x 20" x 6" Jumbo Extension	Green		33 x 51 x 15	32
Bolt							
	0800 2740 031	113BB	2 1/2" x 3/8" SS Bolt	Steel		N / A	600 pcs / box

VALVE BOXES

NDS Standard Series Dimensions

6" Round Valve Boxes

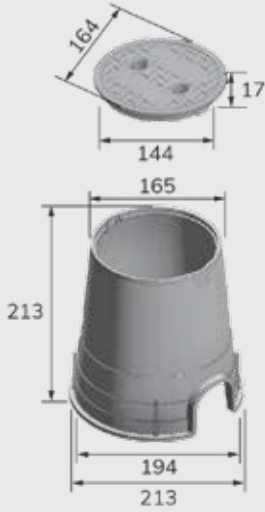

10" Round Valve Boxes

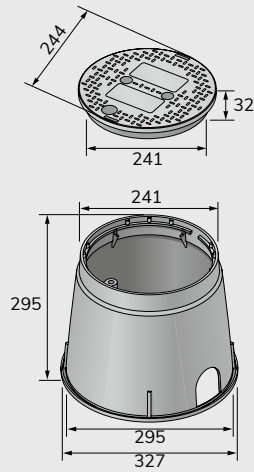

14" x 19" Rectangular Valve Boxes

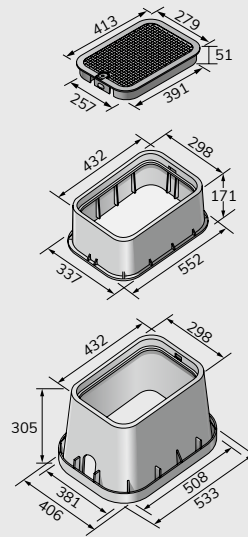

13" x 20" Rectangular Valve Boxes

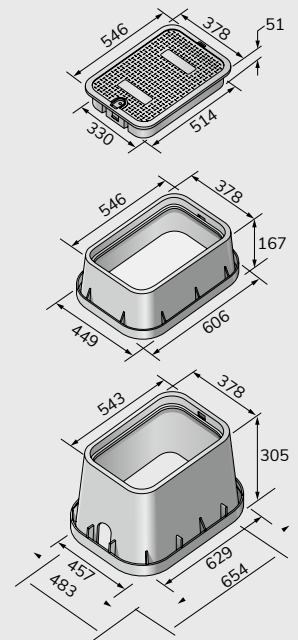

Note: All dimensions in mm